

SIRUBA®

銀箭牌工業用縫紉機
INDUSTRIAL SEWING MACHINE

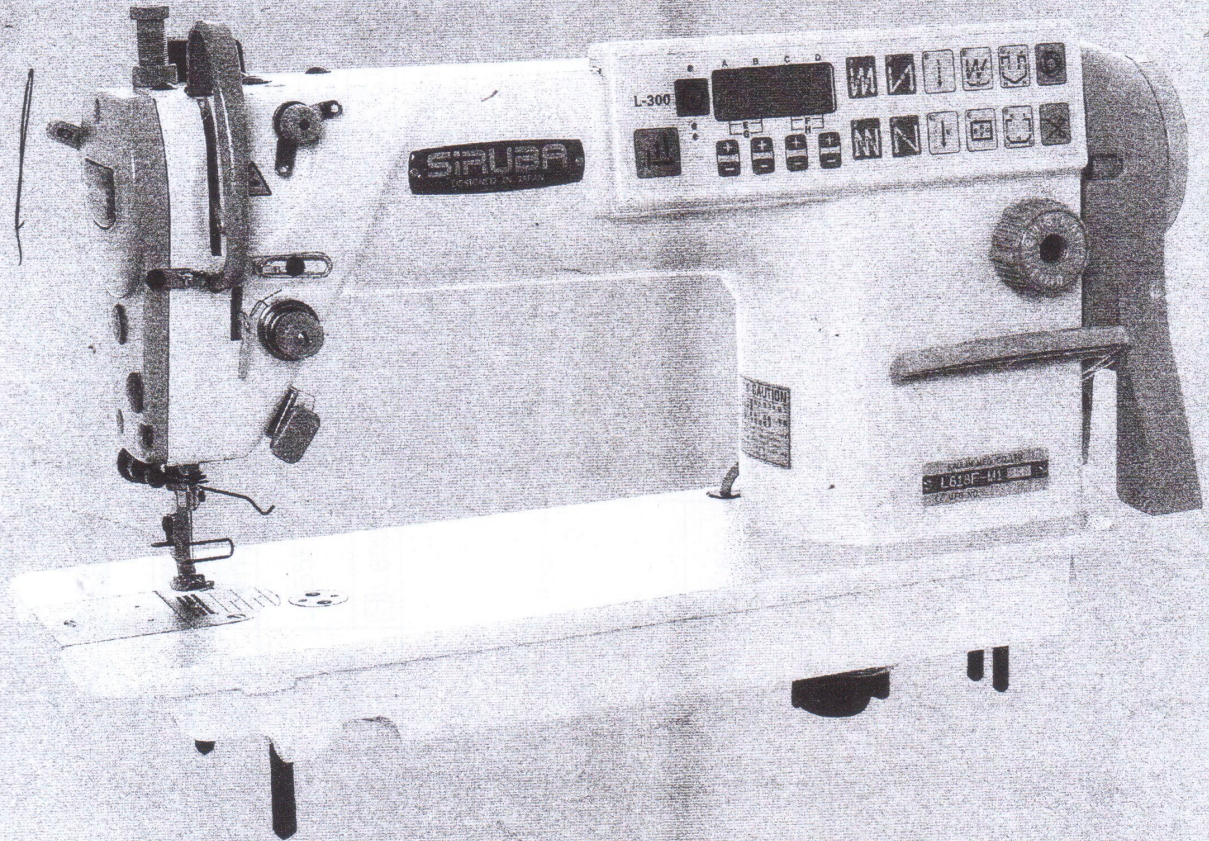









L818F
WITH TRIMMER

零件圖 PARTS LIST













CE

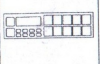









 高林股份有限公司
KAULIN MFG. CO., LTD.

										
MODEL	SUB-CLASS	OPERATING PANEL	NEEDLE PLATE	FEED DOG	PRESSER FOOT	HOOK ASM	BOBBIN CASE ASM	BOBBIN	NEEDLE	HAND WHEEL
機 型	規 格	操作盒	針 板	送 具	押 具	梭 頭	梭 殼	梭 子	針 號	皮 帶 輪
L818F-L1-00 ~ L818F-L1-03	薄布料	LA55F-A	E701 ✓	D701 ✓	P721 ✓	G121 ✓	G202 ✓	G303	DA*1#9	GLH01-A1 ✓
L818F-L1-00A ~ L818F-L1-03A			E701 ✓	D701 ✓	P721 ✓	G121 ✓	G202 ✓	G303	DA*1#9	GLH01Q-E ✓
L818F-L1-10 ~ L818F-L1-13		L600	E701 ✓	D701 ✓	P721 ✓	G121 ✓	G202 ✓	G303	DA*1#9	GLH01-A1 ✓
L818F-M1-00 L818F-M1-03	薄中布	LA55F-A	E704 ✓	D701 ✓	P701 ✓	G121 ✓	G202 ✓	G303	DB*1#11	GLH01-A1 ✓
L818F-M1-00A L818F-M1-03A			E704D ✓	D701 ✓	P701 ✓	G121 ✓	G202 ✓	G303	DB*1#11	GLH01Q-E ✓
L818F-M1A-00 (L818F-M1C-00) L818F-M1A-03 (L818F-M1C-03)			E704D ✓	D702 ✓	P701 ✓	G121 ✓	G202 ✓	G303	DB*1#11	GLH01-A1 ✓
L818F-M1A-00A (L818F-M1C-00A) L818F-M1A-03A (L818F-M1C-03A)			E704D ✓	D702 ✓	P701 ✓	G121 ✓	G202 ✓	G303	DB*1#11	GLH01Q-E ✓
L818F-M1-10 L818F-M1-13	厚布料	L600	E704 ✓	D701 ✓	P701 ✓	G121 ✓	G202 ✓	G303	DB*1#11	GLH01-A1 ✓
L818F-M1A-10 (L818F-M1C-10) L818F-M1A-13 (L818F-M1C-13)			L600	E704D ✓	D702 ✓	P701 ✓	G121 ✓	G202 ✓	G303	DB*1#11









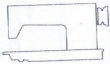

規格件表 CONVERSION CHART-1

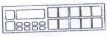















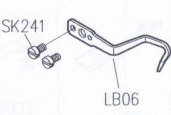

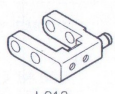



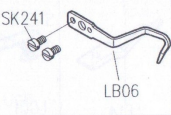

規格件表 CONVERSION CHART-2

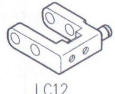
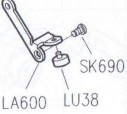
										
MODEL	SUB-CLASS	OPERATING PANEL	NEEDLE PLATE	FEED DOG	PRESSER FOOT	HOOK ASM	BOBBIN CASE ASM	BOBBIN	NEEDLE	HAND WHEEL
機型	規格	操作盒	針板	送具	押具	梭頭	梭殼	梭子	針號	皮帶輪
L818F-HM1-00 L818F-HM1-03	薄中布	LA55F-A	E704	D701	P701	G121	G202	G303	DB*1#11	GLH01-A1
L818F-HM1A-00 L818F-HM1A-03			E704D	D702	P701	G121	G202	G303	DB*1#11	GLH01-A1
L818F-HM1-10 L818F-HM1-13	厚布料	L600	E704	D701	P701	G121	G202	G303	DB*1#11	GLH01-A1
L818F-HM1A-10 L818F-HM1A-13			E704D	D702	P701	G121	G202	G303	DB*1#11	GLH01-A1

										
MODEL	SUB-CLASS	OPERATING PANEL	NEEDLE PLATE	FEED DOG	PRESSER FOOT	HOOK ASM	BOBBIN CASE ASM	BOBBIN	NEEDLE	HAND WHEEL
機型	規格	操作盒	針板	送具	押具	梭頭	梭殼	梭子	針號	皮帶輪
L818F-H1-00	中厚布 至 厚布料	LA55F-A	E711	D711	P711	G122J	G202	G303	DB*1#21	GLH01-A1
L818F-H1-03			E711D	D711D	P711D	G122J	G202	G303	DB*1#21	GLH01Q-E
L818F-H1-00A (L818F-H1C-00)			E711D	D711D	P711D	G122J	G202	G303	DB*1#21	GLH01-A1
L818F-H1-03A (L818F-H1C-03)			E711D	D711D	P711D	G122J	G202	G303	DB*1#21	GLH01Q-E
L818F-H1-10		⊠L600	E711	D711	P711	G122J	G202	G303	DB*1#21	GLH01-A1
L818F-H1-13		⊠L600	E711	D711	P711	G122J	G202	G303	DB*1#21	GLH01-A1
L818F-H1A-10 (L818F-H1C-10)			E711D	D711D	P711D	G122J	G202	G303	DB*1#21	GLH01-A1
L818F-H1A-13 (L818F-H1C-13)			E711D	D711D	P711D	G122J	G202	G303	DB*1#21	GLH01-A1



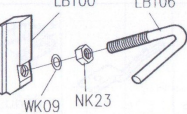









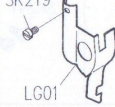
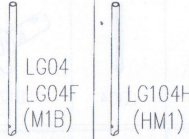

















規格件表 CONVERSION CHART-4















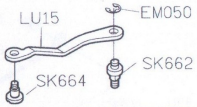

											
MODEL	SUB-CLASS	OPERATING PANEL	NEEDLE PLATE	FEED DOG	PRESSER FOOT	HOOK ASM	BOBBIN CASE ASM	BOBBIN	NEEDLE	HAND WHEEL	
機 型	規 格	操作盒	針 板	送 具	押 具	梭 頭	梭 殼	梭 子	針 號	皮帶輪	
L818F-F1-00 ?	超 薄 布 料	LA55F-A	E731	D731	P721	G113	G202	G303	DB*1SF#9	GLH01-A1	
L818F-F1-03 ?			E731	D731	P721	G113	G202	G303	DB*1SF#9	GLH01Q-E	
L818F-F1-00A ?		H L600	E731	D731	P721	G113	G202	G303	DB*1SF#9	GLH01-A1	
L818F-F1-03A ?			E721	D721	P721	G113	G202	G303	DB*1SF#9	GLH01-A1	
L818F-F1-10 ?		LA55F-A	E721	D721	P721	G113	G202	G303	DB*1SF#9	GLH01Q-E	
L818F-F1-13 ?			E721	D721	P721	G113	G202	G303	DB*1SF#9	GLH01-A1	
L818F-F1-20 ?		H L600	E721	D721	P721	G113	G202	G303	DB*1SF#9	GLH01-A1	
L818F-F1-23 ?			E721	D721	P721	G113	G202	G303	DB*1SF#9	GLH01-A1	
L818F-F1-20A ?		編 織 布 料	LA55F-A	E741	D741	P721	G121	G202	G303	DB*1#9	GLH01-A1
L818F-F1-23A ?				E741	D741	P721	G121	G202	G303	DB*1#9	GLH01Q-E
L818F-F1-30 ?	H L600	E741	D741	P721	G121	G202	G303	DB*1#9	GLH01-A1		
L818F-F1-33 ?		E741	D741	P721	G121	G202	G303	DB*1#9	GLH01Q-E		
L818F-K1-00 ?	編 織 布 料	LA55F-A	E741	D741	P721	G121	G202	G303	DB*1#9	GLH01-A1	
L818F-K1-03 ?			E741	D741	P721	G121	G202	G303	DB*1#9	GLH01Q-E	
L818F-K1-00A ?		H L600	E741	D741	P721	G121	G202	G303	DB*1#9	GLH01-A1	
L818F-K1-03A ?			E741	D741	P721	G121	G202	G303	DB*1#9	GLH01Q-E	
L818F-K1-10 ?	編 織 布 料	LA55F-A	E741	D741	P721	G121	G202	G303	DB*1#9	GLH01-A1	
L818F-K1-13 ?			E741	D741	P721	G121	G202	G303	DB*1#9	GLH01Q-E	

M1									
L1									
H1									

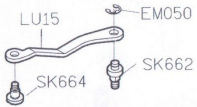
型別件對照表 MODEL COMPARE LIST-1





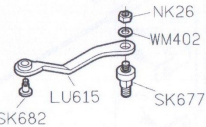







型別件對照表 MODEL COMPARE LIST-2

M1	 LC13	 LC623G	 LE14 HM1	 SK219 LG01	 LG04 LG04F (M1B) LG104H (HM1)	 LG07 LG07F (M1B) (HM1)	 LG09 (HM1)	 LG13	 LG15	 LH06	 LH11
L1	 LC13	 LC23B	 LE14	 SK219 LG01	 LG04	 LG07	 LG09	 LG13	 LG215	 LH06	 LH11
H1	 LC613	 LC600G	 LE614	 SK501 LG101	 LG104 LG104F (H1B)	 LG107 LG107F (H1B)	 LG109	 LG113	 LG615	 LH606	 LH111

M1 HM1	 LU01	 SK660 LU02	 LU03	 LU04	 LU05	 LU15 EM050 SK664 SK662
L1	 LU01	 SK660 LU02	 LU03	 LU04	 LU05	 LU15 EM050 SK664 SK662
H1	 LU601	 SK683 LU602	 LU603	 LU604	 LU605	 LU15 EM050 SK664 SK662 NK26 WM402 LU615 SK682 SK677

型別件對照表 MODEL COMPARE LIST-3

型別件對照表 MODEL COMPARE LIST-4

M1 HM1	 LU18	 LU25	 LU26	 LU28	
L1	 LU18	 LU25	 LU26	 LU28	
H1	 LU618	 LU625	 LU626	 LU628	



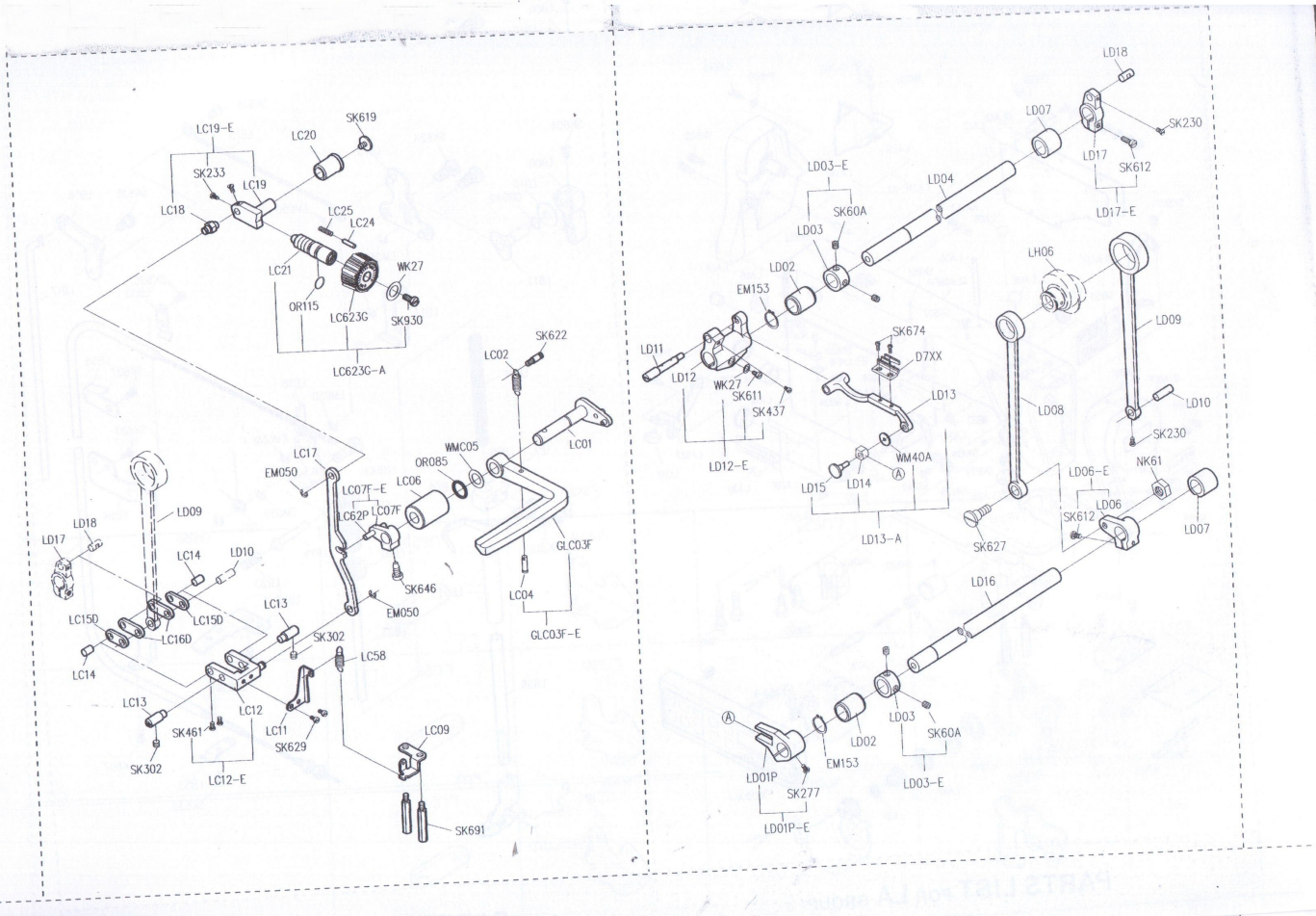

PARTS LIST FOR L10000

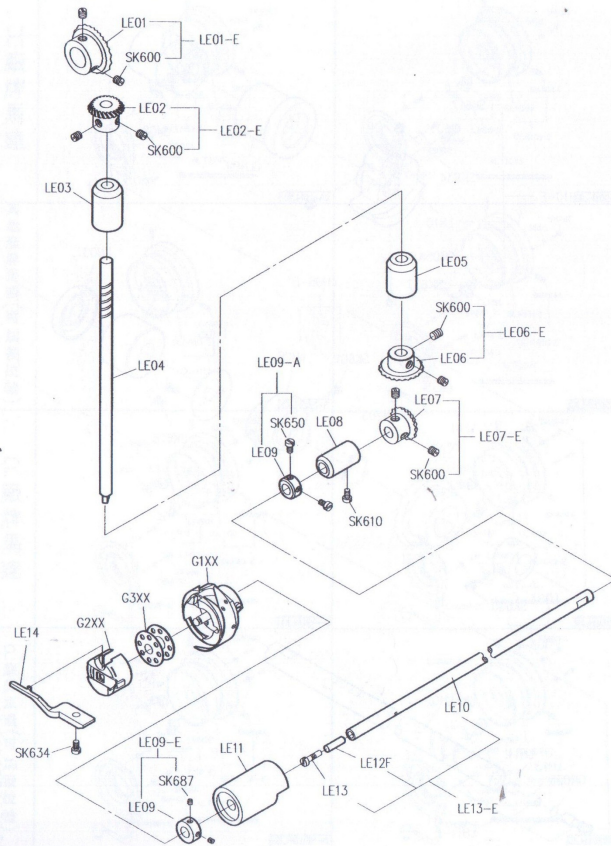

PARTS LIST FOR LE GROUP

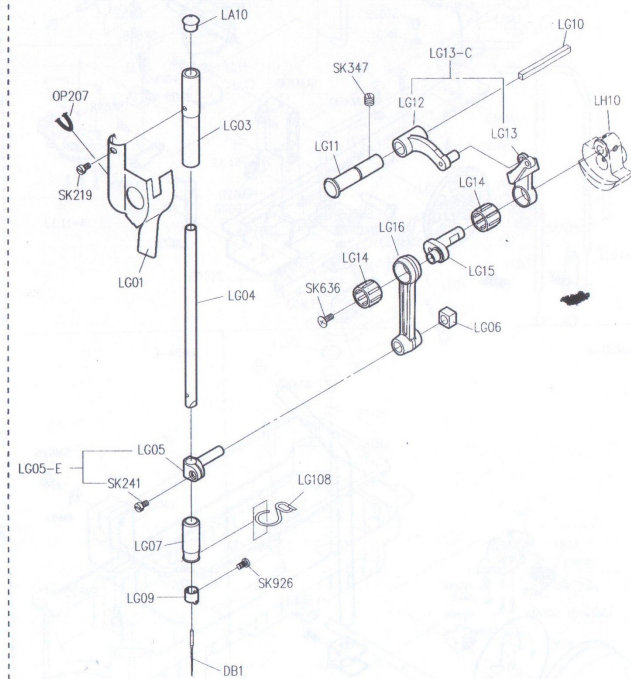

PARTS LIST FOR LG GROUP

PARTS LIST FOR LM GROUP

PARTS LIST FOR LH (1) GROUP

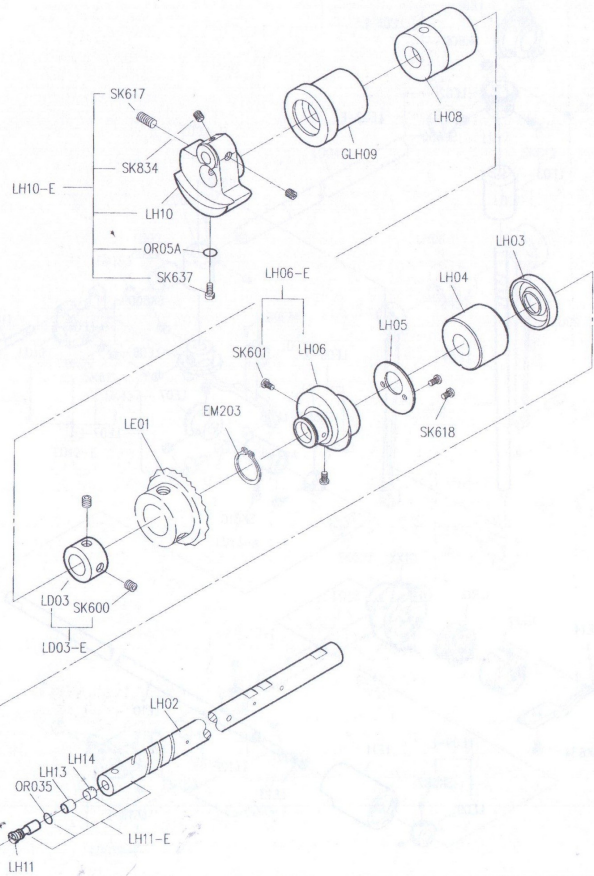
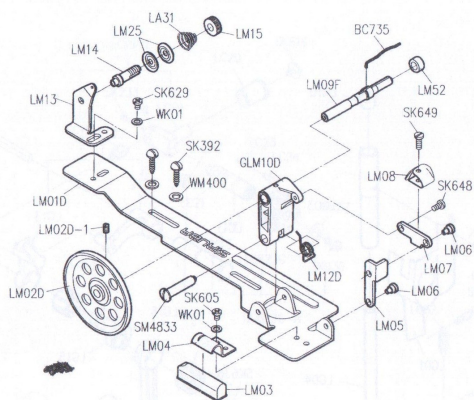

LM20-A

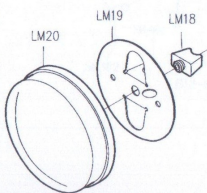

LM24-E

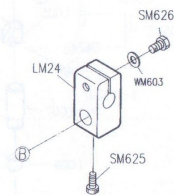

H 廠牌馬達

擺動式切刀

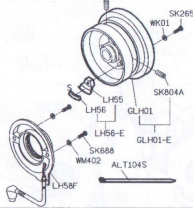

GLH01-A1

旋轉式切刀

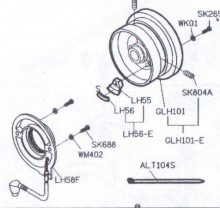

GLH01-A1

其他廠牌馬達 (可加後拉輪)

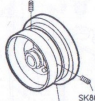

GLH01Q-E

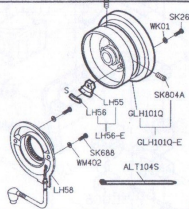

GLH101Q-A1

P 廠牌馬達

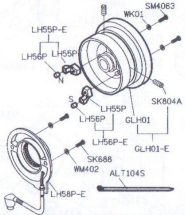

GLH01P-A

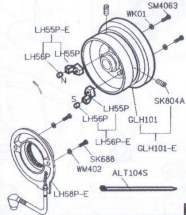

GLH101P-A

P 廠牌馬達 (可加後拉輪)

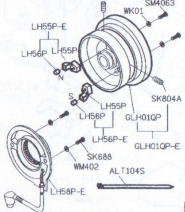

GLH101QP-A

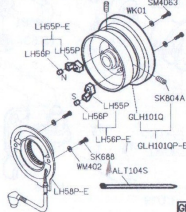

GLH101QP-A

PARTS LIST FOR LH (2) GROUP

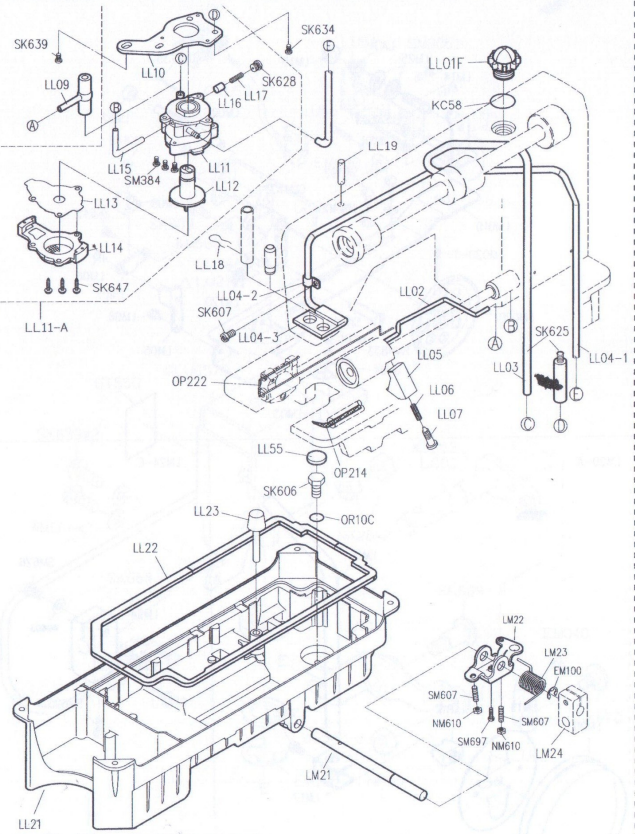

PARTS LIST FOR LL GROUP

PARTS LIST FOR LM GROUP

PARTS LIST FOR LU (1) GROUP

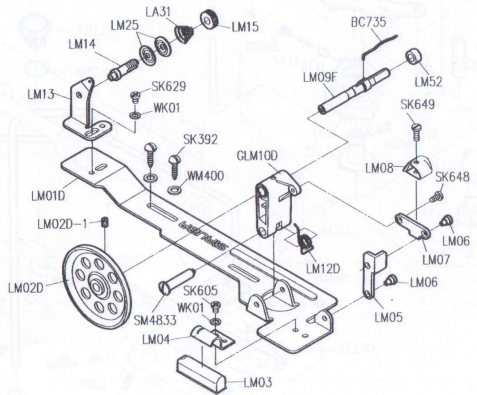

LM20-A

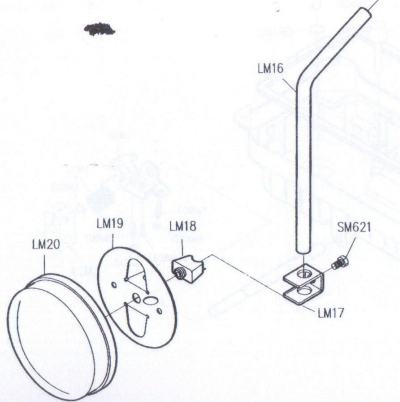

LM24-E

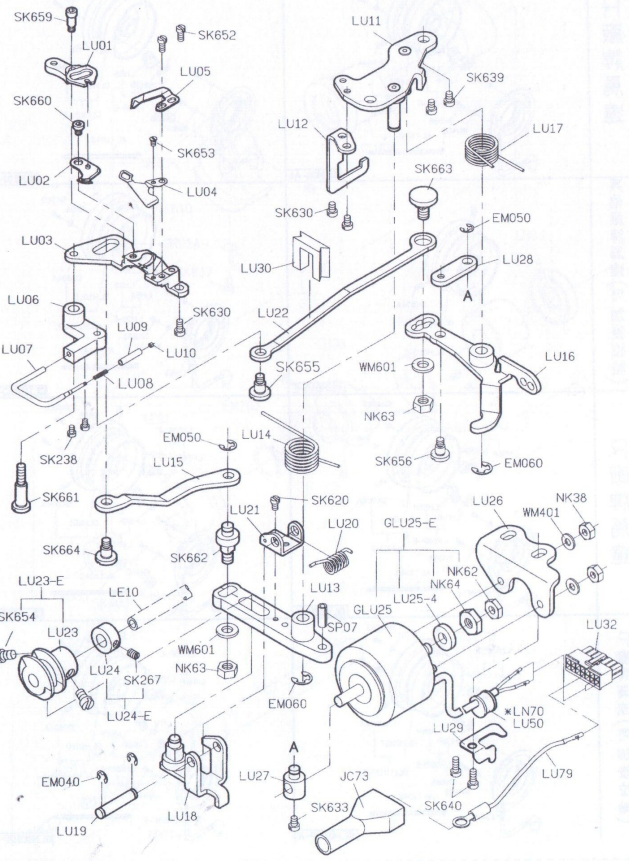
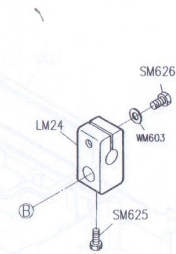

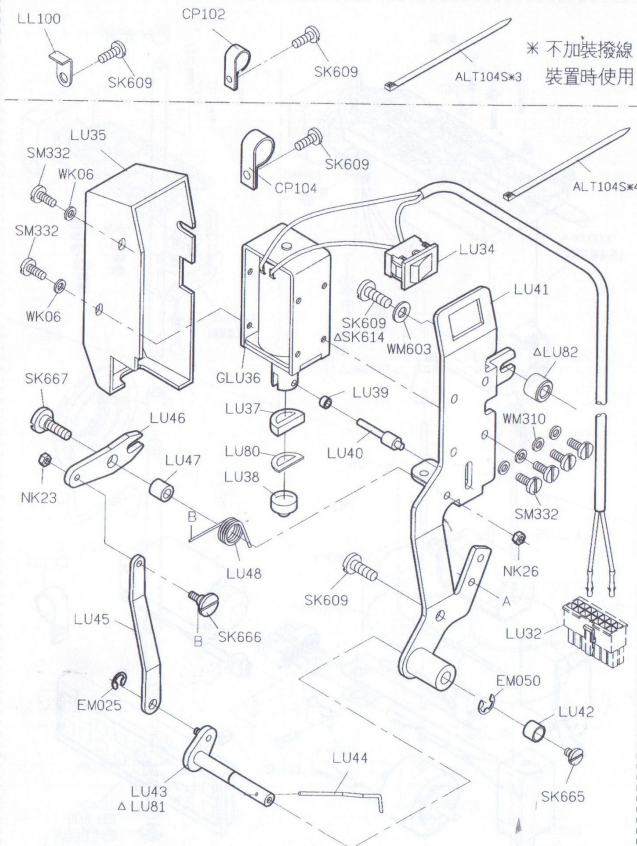

PARTS LIST FOR LU (2) GROUP

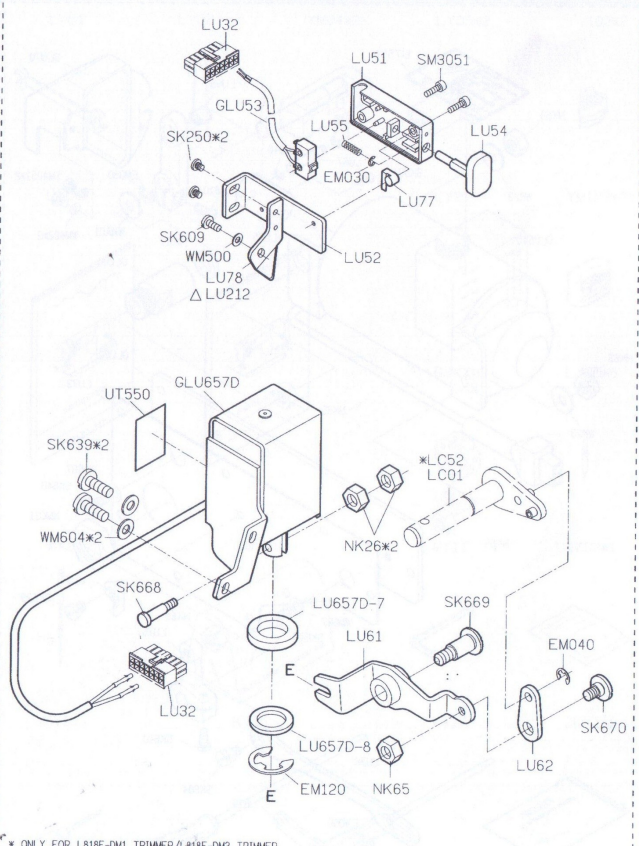

* ONLY FOR L818F-DM1 TRIMMER/L818F-DM3 TRIMMER
 Δ ONLY FOR L818F-RM1 TRIMMER

PARTS LIST FOR LU (3) GROUP

PARTS LIST FOR LU (4) GROUP

PARTS LIST FOR LU (5) GROUP

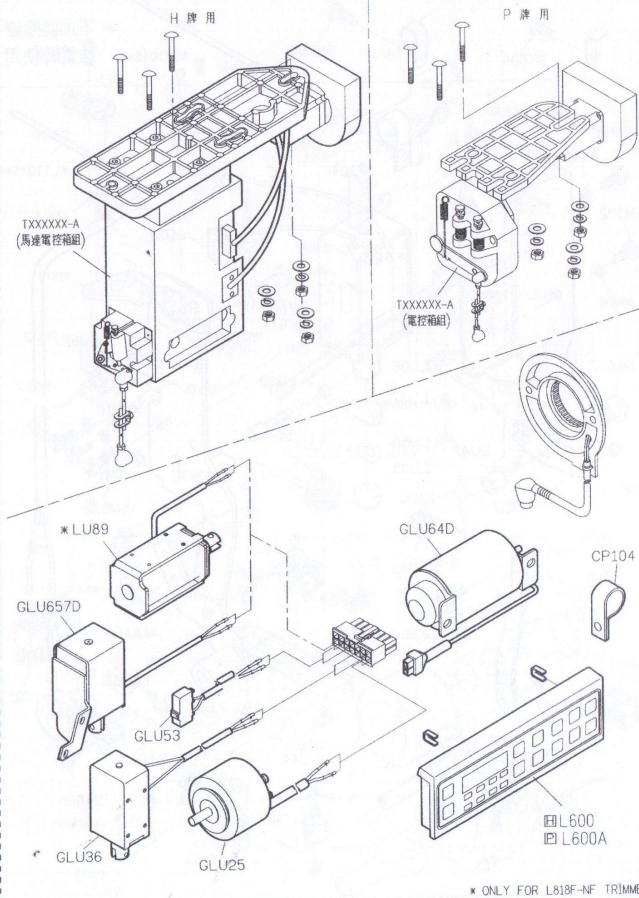
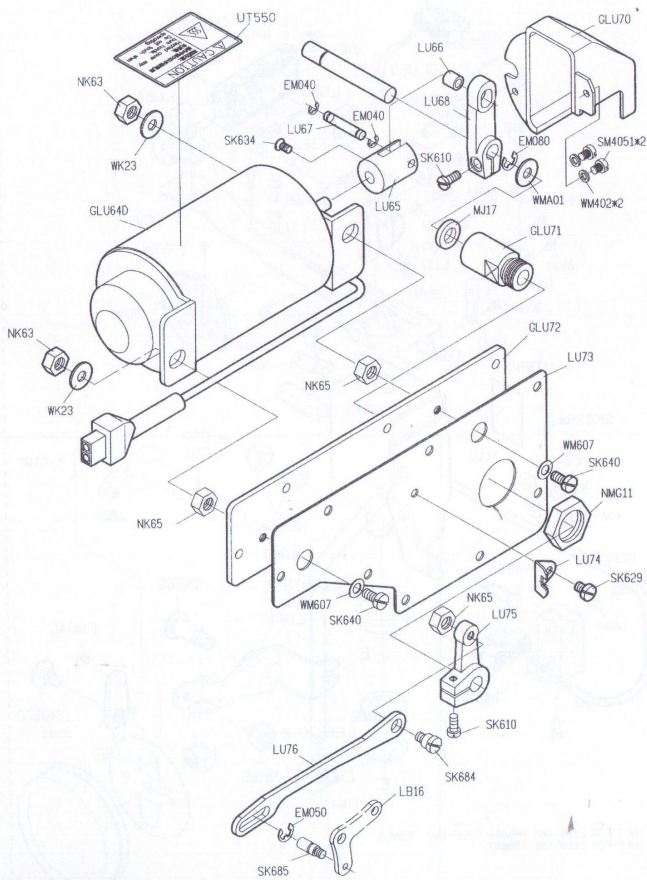

* ONLY FOR L818F-NF TRIMMER

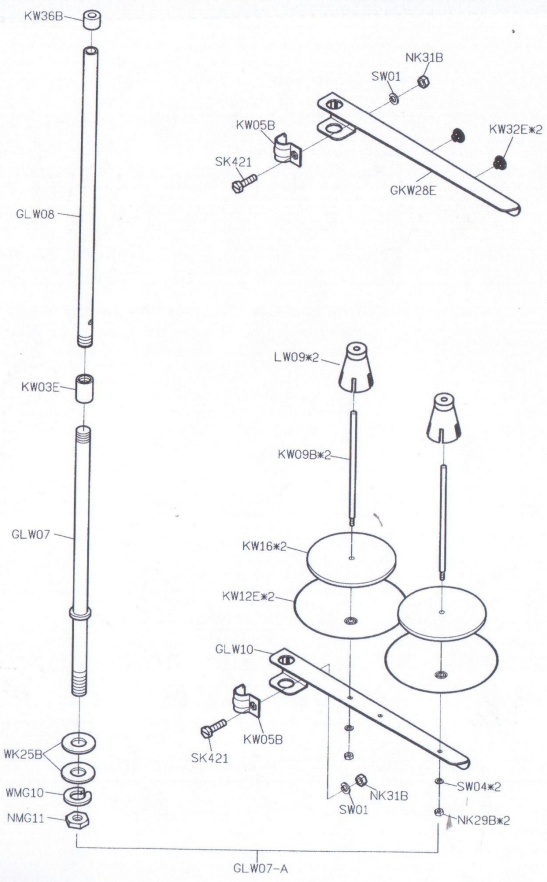

PARTS LIST FOR THREAD STAND GROUP

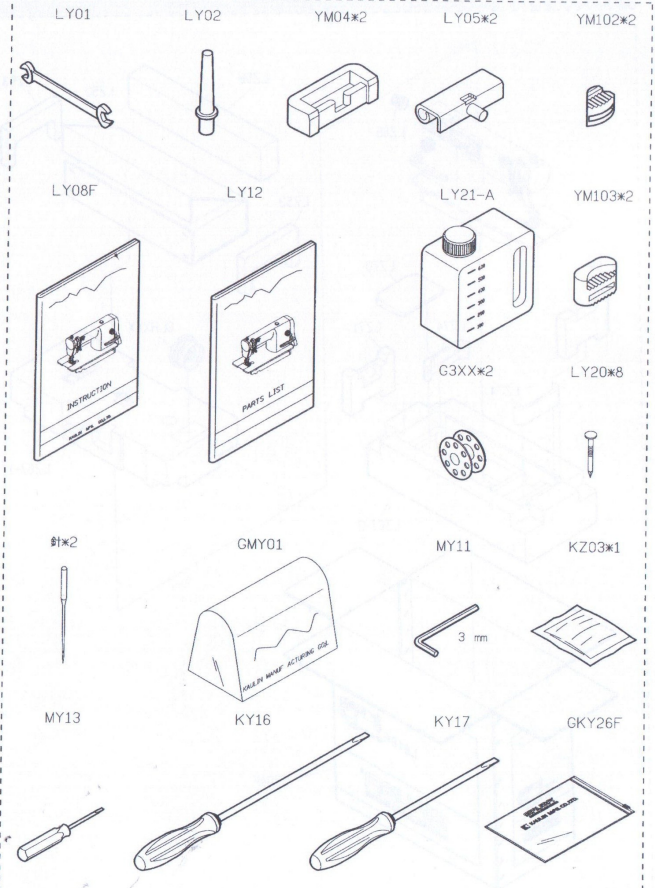

PARTS LIST FOR LY GROUP

PARTS LIST FOR LZ GROUP

